

Overview

Computer Vision II

CSE 252B

CSE 252B: Computer Vision II

- CSE 252A: Computer Vision I is not a prerequisite
- Today
 - Course overview
 - Logistics
 - Lecture: Geometric primitives
- Lectures will be boardwork with occasional slides (for difficult figures) and videos

Principal Topic

- Imaging geometry
 - Single-, two-, three-, and n -view geometry
 - Calibrated and uncalibrated

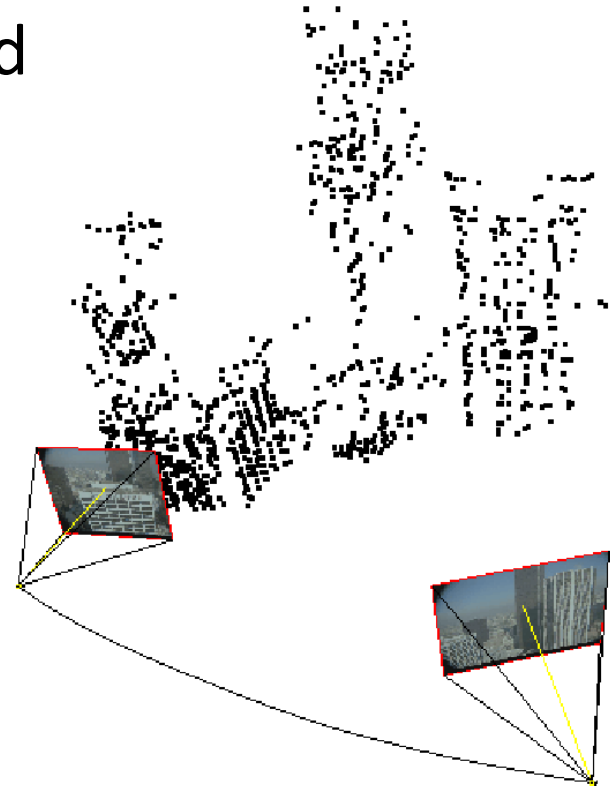
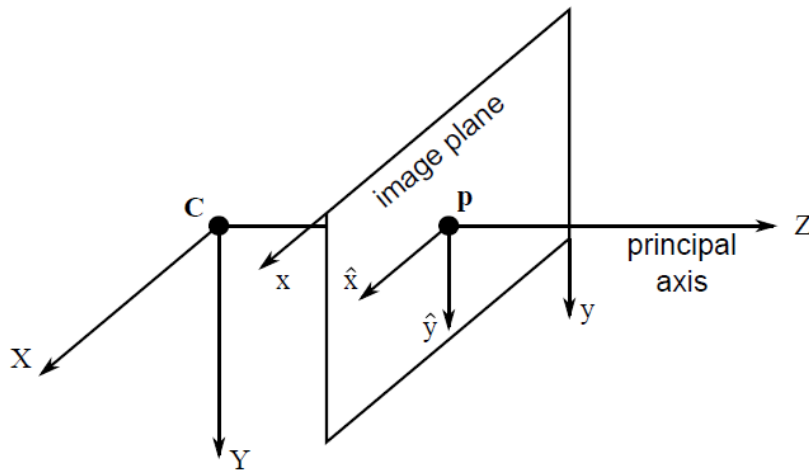

Geometric Primitives

- Points
- Hyperplanes
 - 2D lines, 3D planes, n -D hyperplanes
- Hyperquadrics
 - 2D conics, 3D quadrics, n -D hyperquadrics
- Dual hyperquadrics
- 3D lines and dual lines

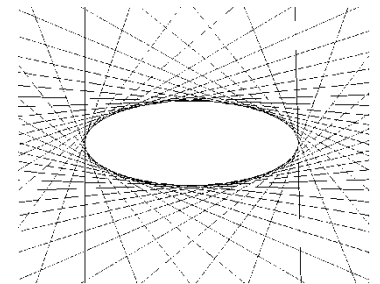
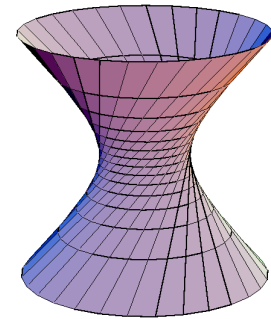

Feature Detection and Matching



Input Images

Feature Detection and Matching

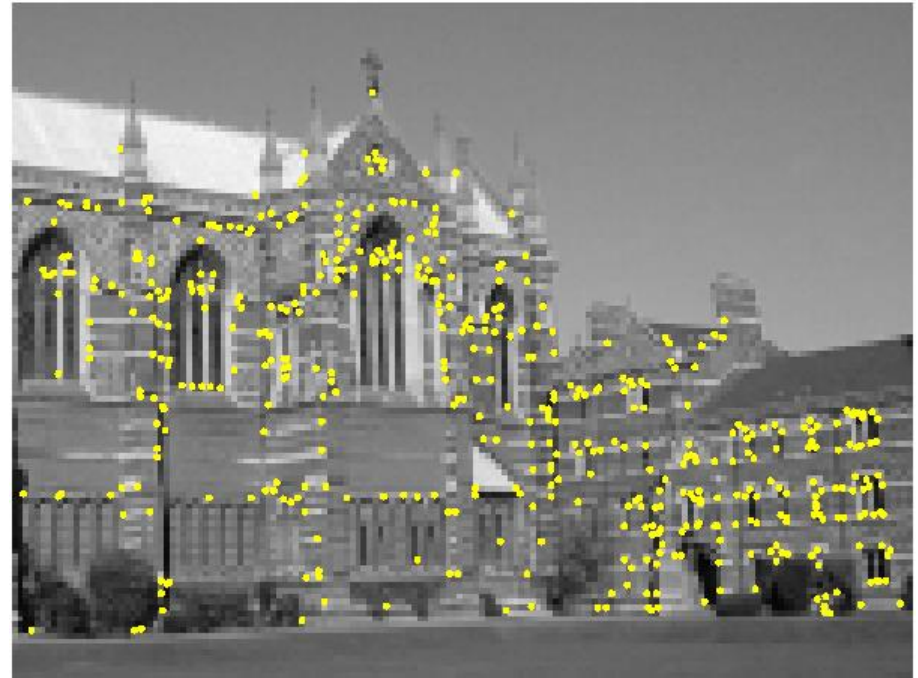
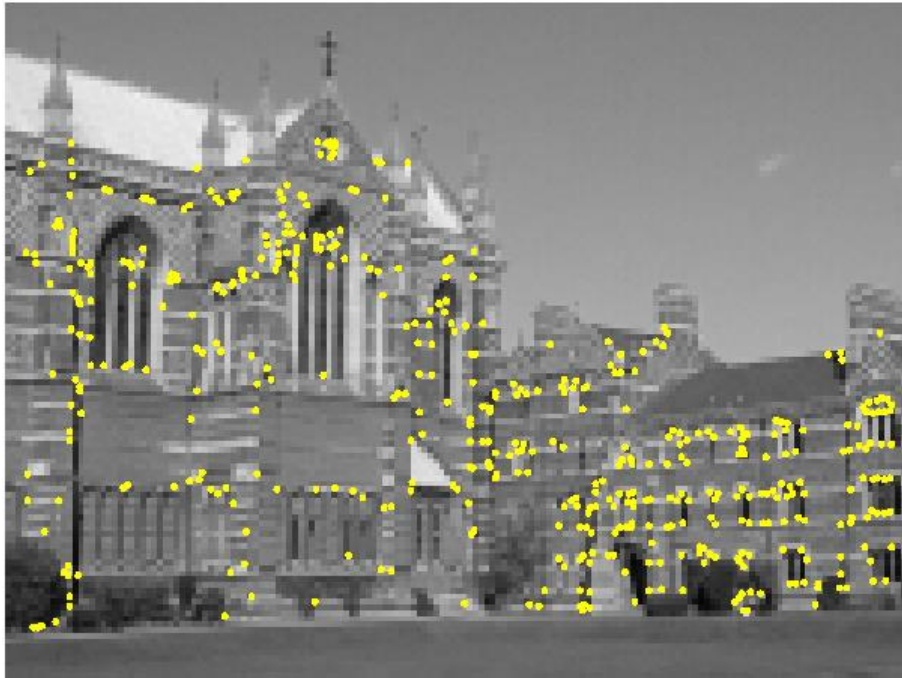

Detected Corners

Feature Detection and Matching

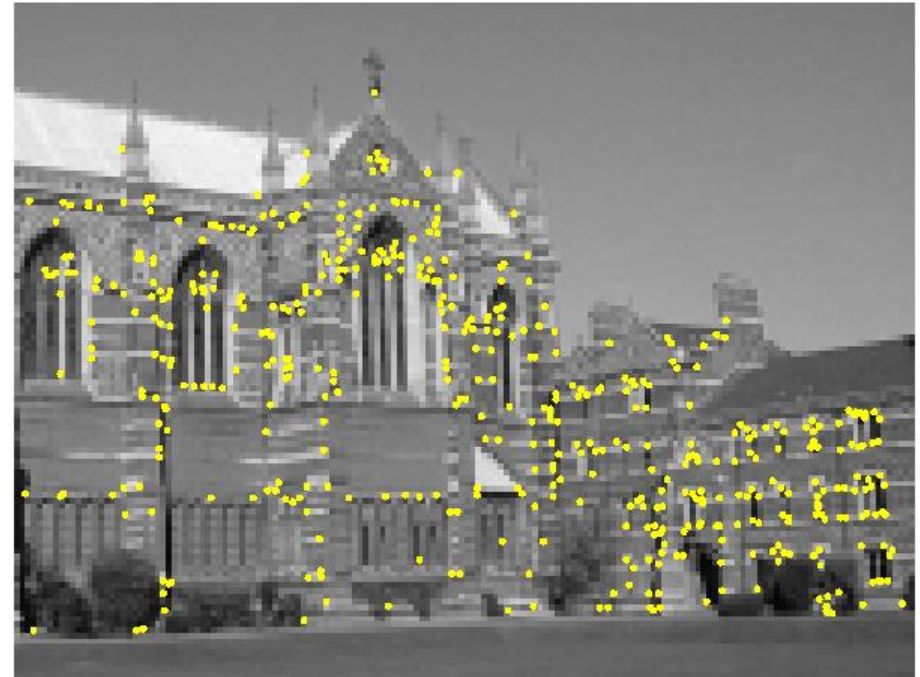
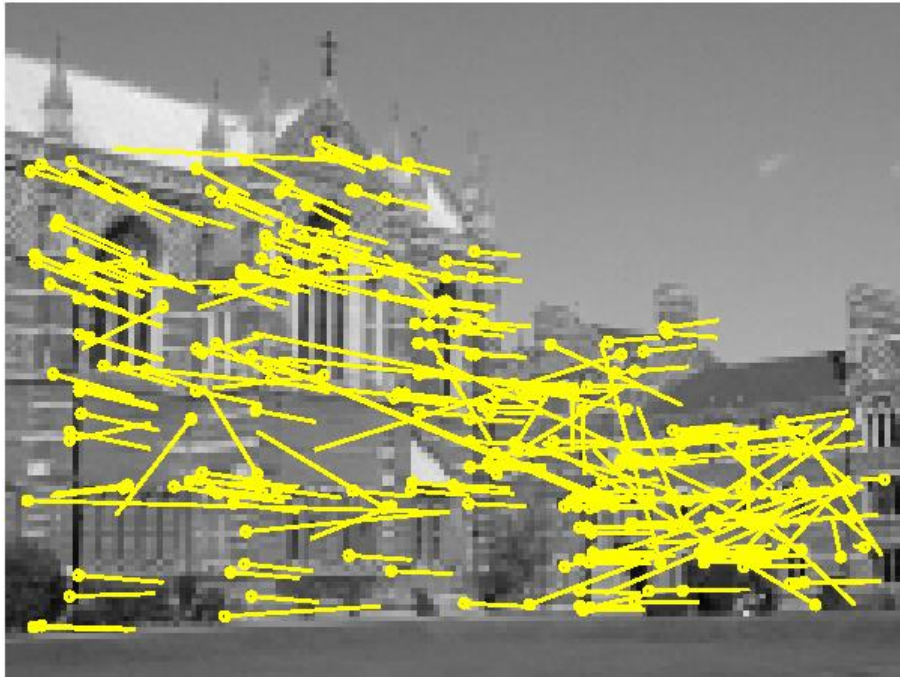

Simple Matching

Feature Detection and Matching

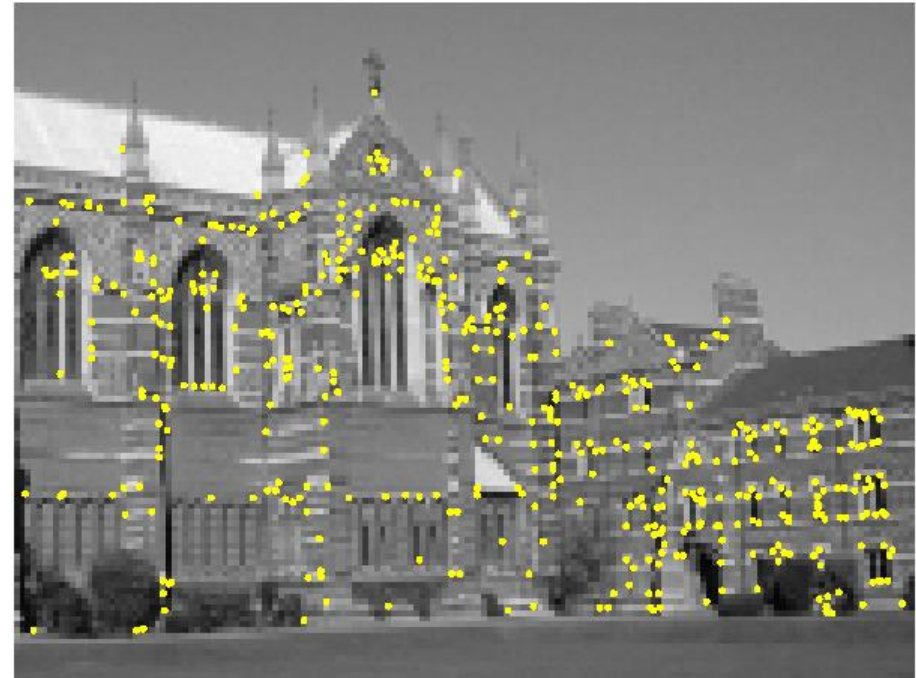
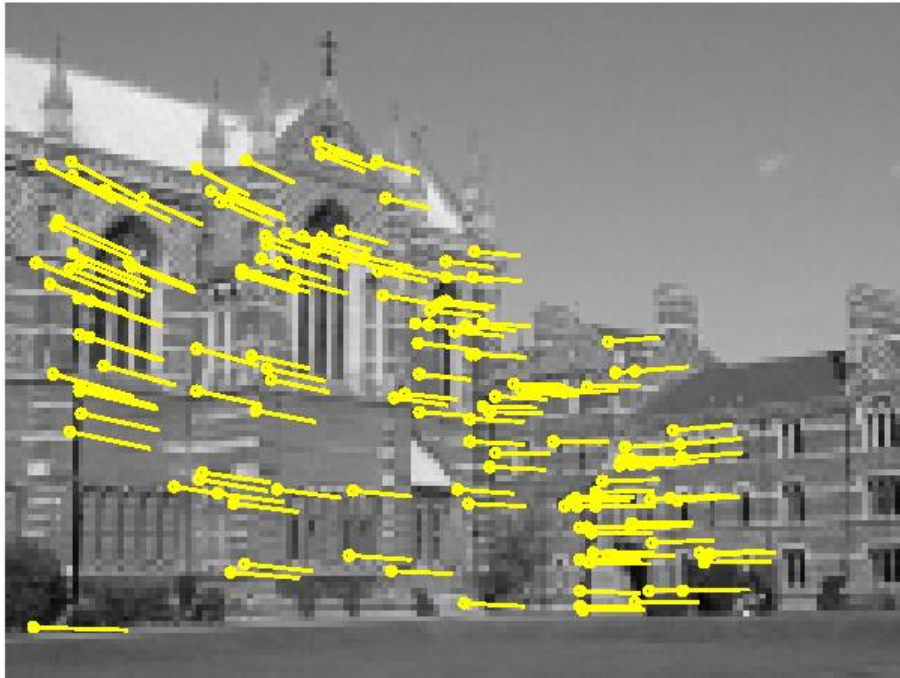

Simple Matching
Including Outlier Rejection

Geometric Transformations

- Euclidean
 - Rotation and translation
- Similarity
 - Rotation, scale, and translation
- Affine
 - Linear and translation
- Projective

Single-View Geometry

- Camera projection matrix
 - Uncalibrated
 - Rotation, translation, and calibration matrix
- Normalized camera projection matrix
 - Calibrated
 - Rotation and translation (pose)

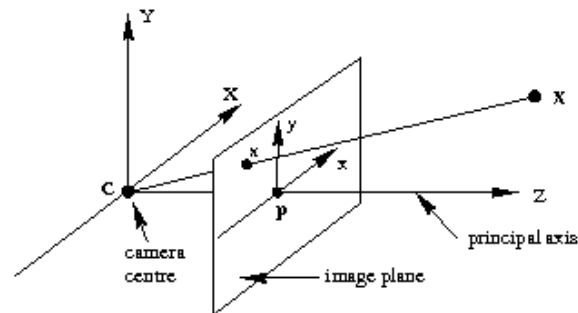

Projection and Back-Projection

- Projection
 - Same dimension
 - e.g., 2D to 2D
 - Higher dimension to lower dimension
 - e.g., 3D to 2D
- Back-projection
 - Lower dimension to higher dimension
 - e.g., 2D to 3D
 - Introduces ambiguity

Two-View Geometry

- Fundamental matrix
 - Uncalibrated
- Essential matrix
 - Calibrated

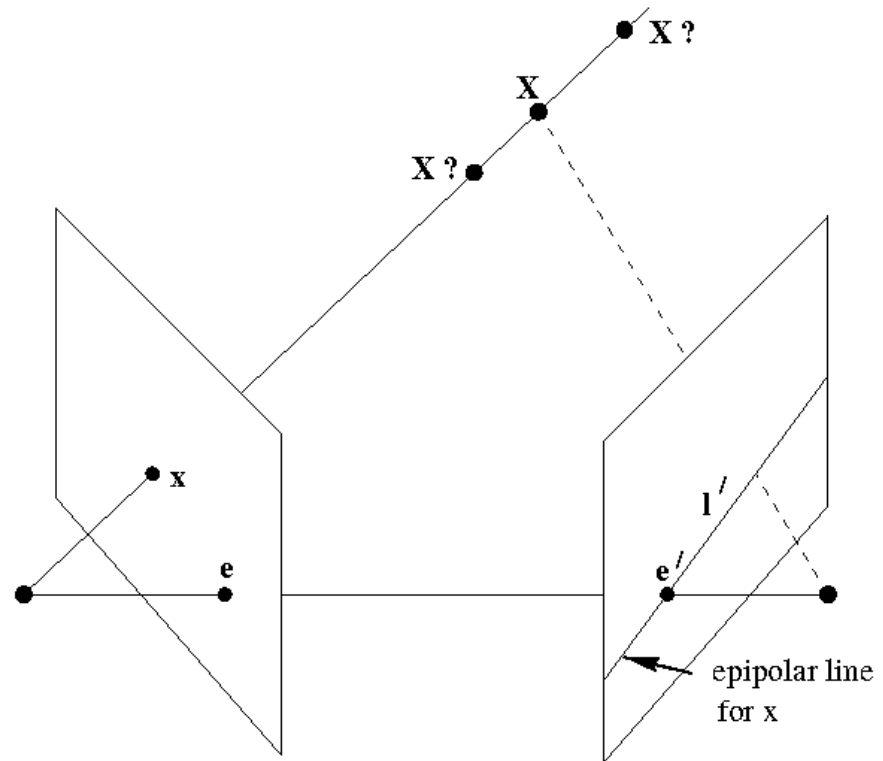

Camera Rotation Only

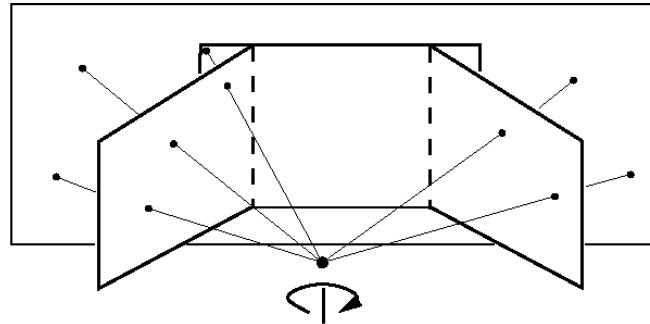

Mosaic construction from images

Two-View Triangulation

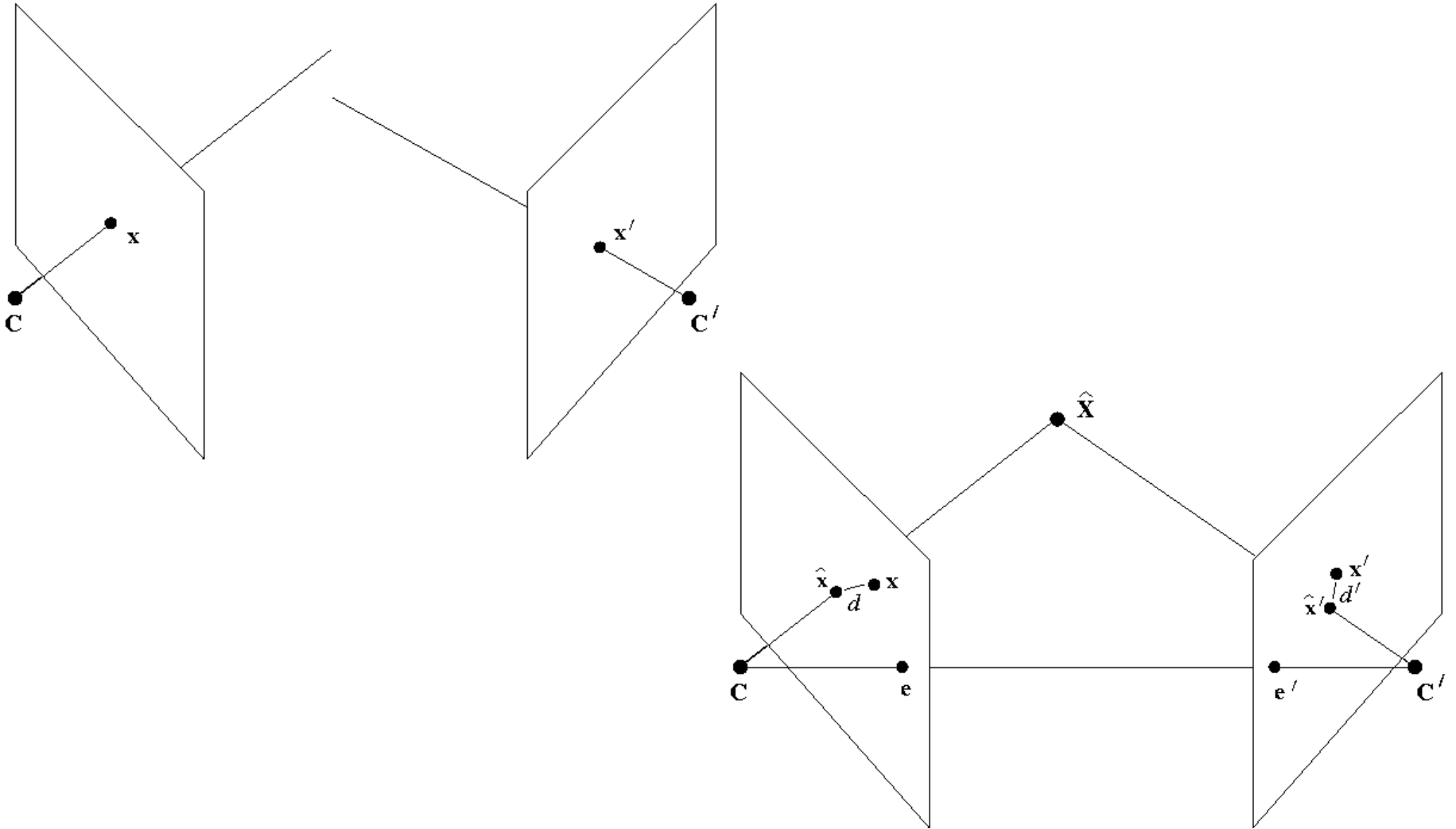

Three-View Geometry

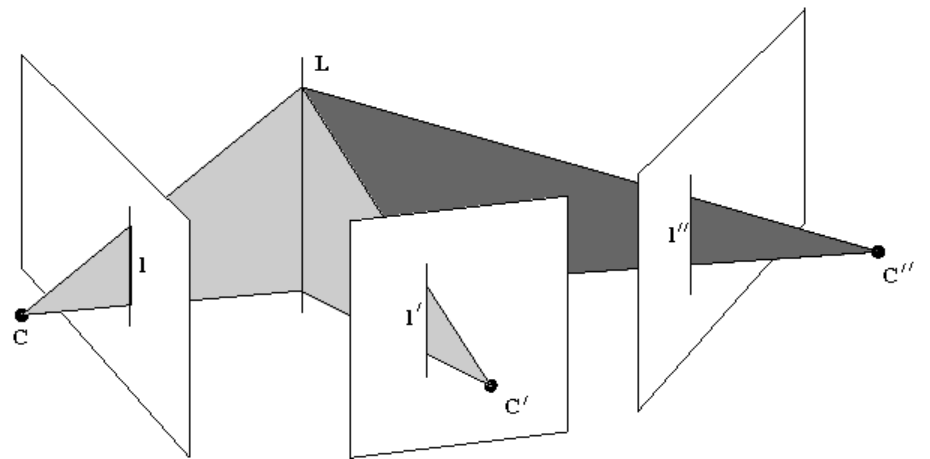
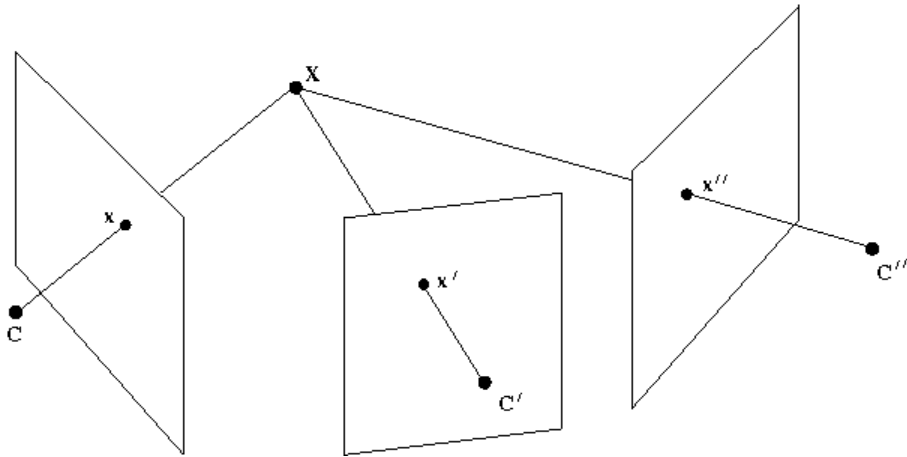

Other Topics

- n -view geometry
 - Triangulation
 - Bundle adjustment and 2D block adjustment
- From projective to affine and metric reconstruction
- Auto-calibration

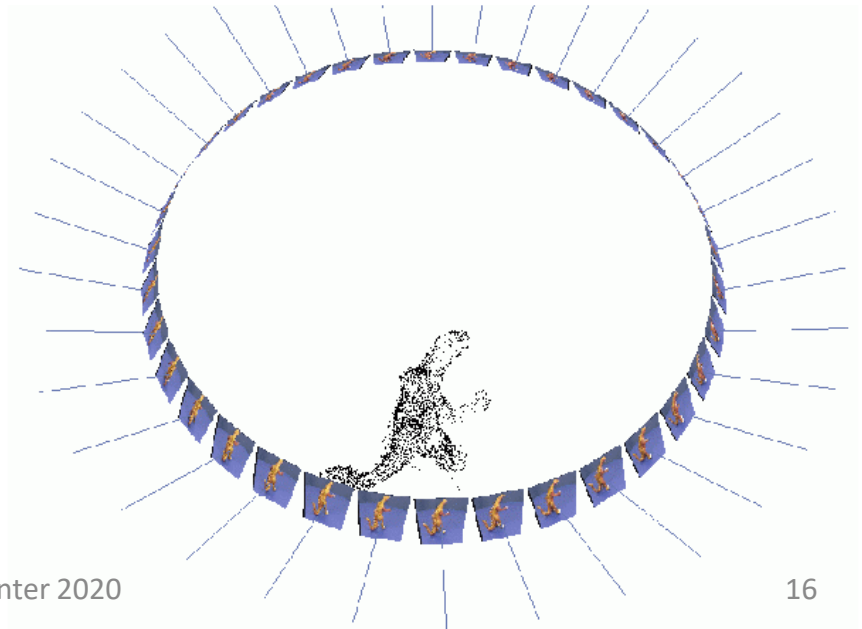

Common Problem: Model Estimation

- Minimal solution
 - Used in outlier rejection
- Linear estimation
- Nonlinear optimization
 - Use linear estimation for initial estimate
 - Iterative process to determine global optimum

Results



The Syllabus

- Instructor: Ben Ochoa
- TA: Joseph Li
- Course website
 - <https://cseweb.ucsd.edu/classes/wi20/cse252B-a/>
- 18 lecture meetings
 - 2 university holidays (Jan 20 and Feb 17)
- Class discussion
 - Piazza

The Syllabus

- Grading
 - 5 homework assignments (100% of grade)
 - By hand and programming using Python
 - Significant amount of work, but rewarding
 - Start early!
 - Prepare reports using Markdown or LaTeX
 - Late policy: 15% grade reduction for each 12 hours late
 - Will not be accepted 72 hours after the due date
 - No midterm exams
 - No final exam
 - Piazza
 - Ask (and answer) questions using Piazza, not email
 - Good participation could raise your grade (e.g., raise a B+ to an A-)

Textbook

- Multiple View
Geometry in Computer
Vision, 2nd edition
 - Richard Hartley and
Andrew Zisserman
- Download the
corrections and errata

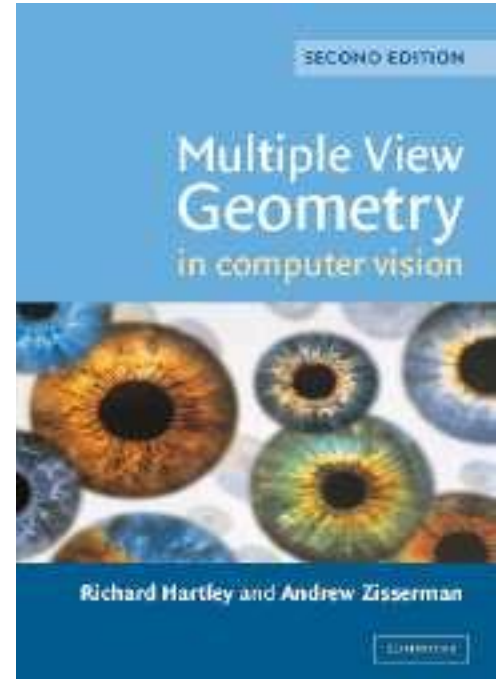

Collaboration Policy

It is expected that you complete your academic assignments on your own and in your own words and code. The assignments have been developed by the instructor to facilitate your learning and to provide a method for fairly evaluating your knowledge and abilities (not the knowledge and abilities of others). So, to facilitate learning, you are authorized to discuss assignments with others; however, to ensure fair evaluations, you are not authorized to use the answers developed by another, copy the work completed by others in the past or present, or write your academic assignments in collaboration with another person.

Academic Integrity Policy

Integrity of scholarship is essential for an academic community. The University expects that both faculty and students will honor this principle and in so doing protect the validity of University intellectual work. For students, this means that all academic work will be done by the individual to whom it is assigned, without unauthorized aid of any kind.

Academic Integrity Violation

If the work you submit is determined to be other than your own, you will be reported to the Academic Integrity Office for violating UCSD's Policy on Integrity of Scholarship. In accordance with the CSE department academic integrity guidelines, ***students found committing an academic integrity violation will receive an F in the course.***

Wait list

- Number of enrolled students is limited by
 - Size of room
 - Number of instructional assistants (TAs and tutors)
- General advice
 - Wait for as long as you can
- UCSD policy: concurrent enrollment (Extension) students have lowest priority